

HIGH-EFFICIENCY CATHODE LIGHT STRIP (Model H-CLS)



Patent 7,293,895
Patent 6,454,431



Beautiful, functional, dimmable, easy to specify and install...your best choice for seamless cove lighting, in an ultra-long lamp life, ultra-low wattage luminaire.



8020 Queenair Drive, Gaithersburg, MD 20879 USA • ph: 301 921 4120 • fax: 301 963 3050
email: info@CathodeLightingSystems.com • website: www.CathodeLightingSystems.com

HIGH-EFFICIENCY CATHODE LIGHT STRIP (Model H-CLS)







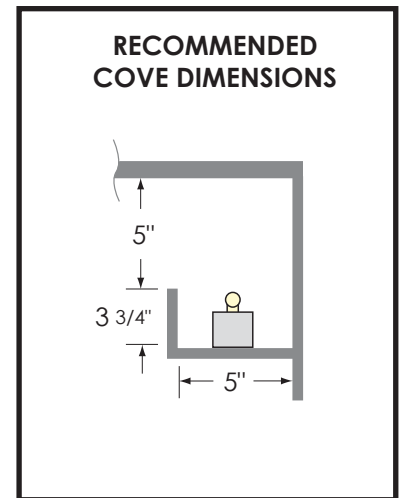
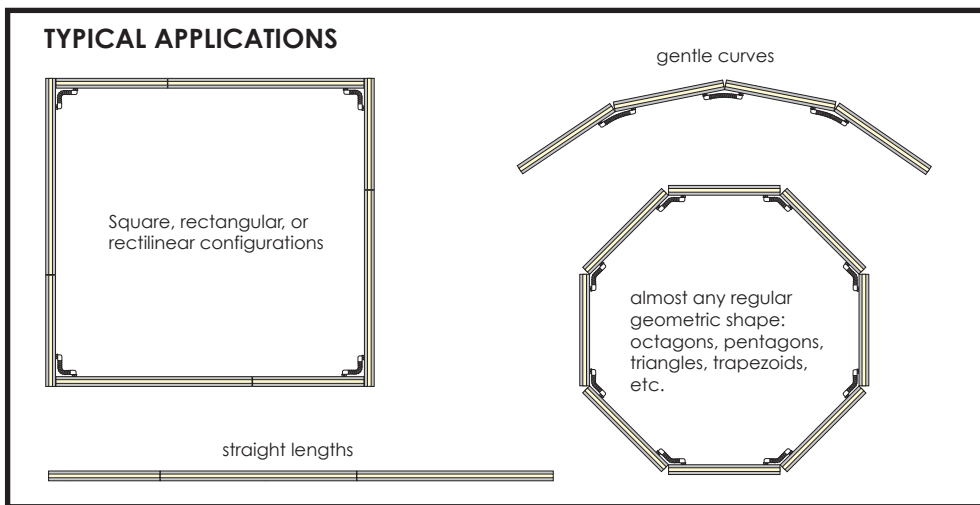



**FEATURES & BENEFITS
DESIGN & DIMENSIONAL INFORMATION**

FEATURES & BENEFITS

- Illumination is seamless from end to end, with no dark spots or socket shadow
- Luminaires are available in 10 standard sizes, from 3 feet to 7.5 feet (in 6" increments)
- Reliable, long-life high color-rendering T6 cold cathode lamps (up to 100,000 hours of life)
- Up to 997 feet of fixtures on one 20-amp circuit @ 277 volts, or 427 feet of fixtures @ 120 volts
- Lamps snap in and out of luminaires via innovative zero-clearance lamp bases and lampholders
- New electronic ballast technology offers inaudible operation and a power factor >.95
- Low profile - only 3.5" tall with lamp installed
- All luminaires are equipped with integral 1% dimming ballasts and are compatible with 3-wire fluorescent dimmers
- All luminaires dim at the same rate, regardless of variations in lamp length
- Wide color selection, including 10 different white hues to choose from



DIMENSIONAL INFORMATION

- Model H-CLS-3  Length: 36"
- Model H-CLS-3.5  Length: 40"
- Model H-CLS-4  Length: 48"
- Model H-CLS-4.5  Length: 54"
- Model H-CLS-5  Length: 60"
- Model H-CLS-5.5  Length: 66"
- Model H-CLS-6  Length: 72"
- Model H-CLS-6.5  Length: 78"
- Model H-CLS-7  Length: 84"
- Model H-CLS-7.5  Length: 90"

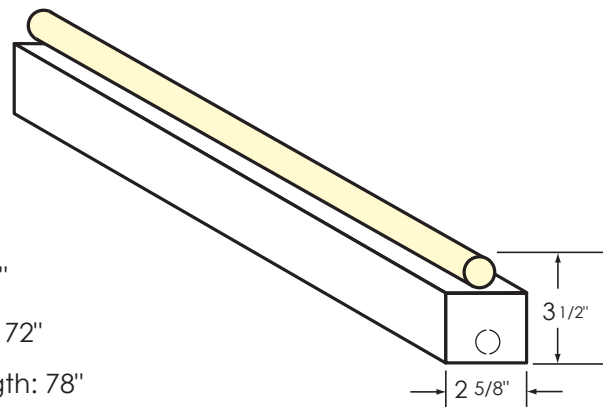

HIGH-EFFICIENCY CATHODE LIGHT STRIP (Model H-CLS)

LAMP COLORS & ORDERING INFORMATION

LAMP COLORS

WHITE LAMPS: All whites are triphosphor with a CRI of 92

Cat. No.	Shade of White	Lumens per foot	Efficacy
28TC	Incandescent white - 2800°K	257	77.2 lumens/watt
30TC	Warm white - 3000°K	253	76.2 lumens/watt
35TC	Soft white - 3500°K	260	78.2 lumens/watt
42TC	Cool white - 4200°K	250	75.3 lumens/watt
50TC	Ice white - 5000°K	246	73.2 lumens/watt
65TC	Daylight - 6500°K	250	75.4 lumens/watt

COLORED LAMPS:

- Pink White (PW)
- Hot Pink (HP)
- Red (RD)
- Lavender (LV)
- Purple (PR)
- Sky Blue (SB)
- Deep Blue (DB)
- Turquoise (TQ)
- Aquamarine (AQ)
- Standard Green (GR)
- Bright Green (BG)
- Gold (GD)
- Canary Yellow (CY)
- Orange (OR)

Photometric information: All photometric values provided by LTL (Luminaire Testing Laboratories, Allentown, PA).

ORDERING INFORMATION

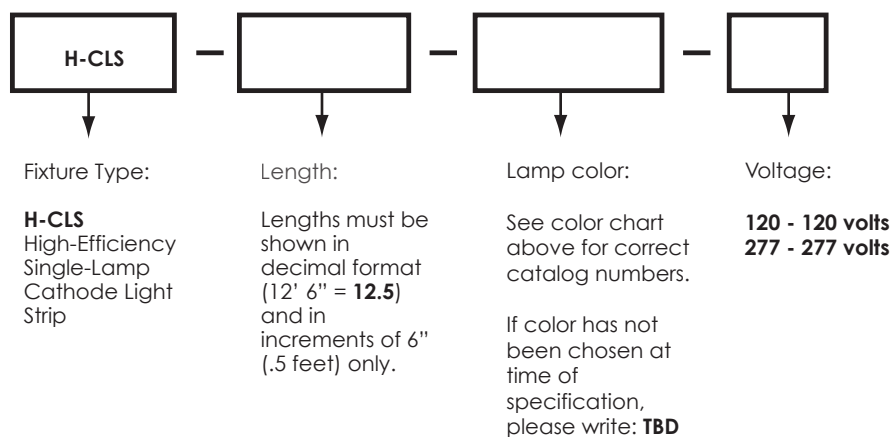

Example: One straight light cove, 93.5' in length. Lamp color is 3500°K soft white. Fixtures will operate at 277 volts.

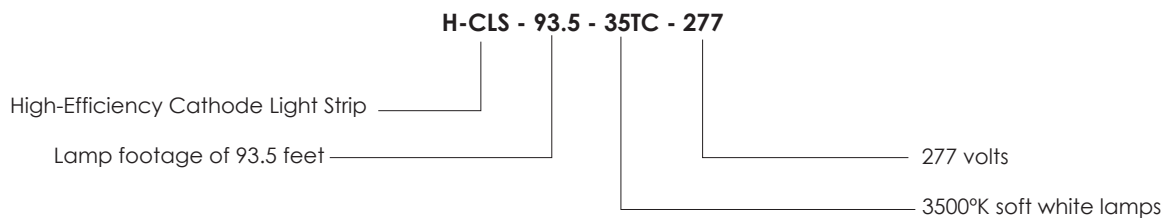

HIGH-EFFICIENCY CATHODE LIGHT STRIP (Model H-CLS)

ELECTRICAL INFORMATION & SPECIFICATIONS

ELECTRICAL INFORMATION

Ballast type	Primary voltage	Primary amps / VA	Watts per foot*	Dimming protocol	Maximum luminaires per 20-amp circuit*	Maximum lamp footage per 20-amp circuit*
Electronic	120 volts 50/60 Hz	.28 amps / 34 VA	4.5	3-wire fluorescent	57 @ 120 volts	427 feet
Electronic	277 volts 50/60 Hz	.12 amps / 34 VA	4.5	3-wire fluorescent	133 @ 277 volts	997 feet

*Values are based on all fixture lengths at 7'6". Actual values may vary dependent upon selected luminaire lengths.

Primary Wiring: Branch circuit wiring must contain three (3) conductors + ground in order to utilize dimming feature.

Branch circuit requirements: H-CLS luminaires must be powered by a dedicated circuit only. Maximum breaker size is 20 amps.

DIMMING: Luminaires are dimmable utilizing 3-wire fluorescent dimmers. Lutron is preferred.

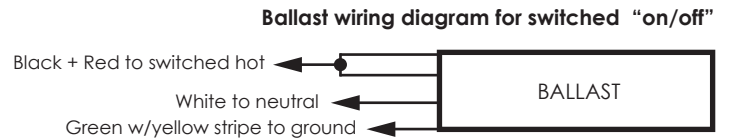
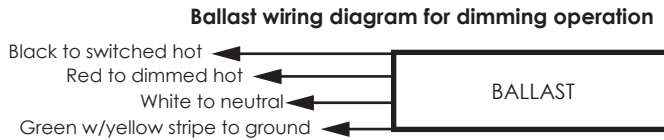

SPECIFICATIONS:

Luminaire: Shall be Cathode Lighting Systems model H-CLS (High-Efficiency Cathode Light Strip), and shall be available in ten (10) standardized straight lengths from 3 feet to 7.5 feet long. Luminaires shall provide a continuous, uninterrupted line of light when installed as instructed. Luminaires shall be pre-assembled, satin-anodized .060" aluminum with a snap-fit cover and one (1) integral, dimmable electronic ballast.

Lamps: Shall be 100,000-hour T6 cold-cathode fluorescent, color as specified. Lamps shall be provided with single-pin bases for zero-clearance snap-in installation and removal from lampholders. Lamps that are hard-wired to the power supply are not acceptable alternatives. Lamps shall be manufactured with butt-sealed ends to provide complete illumination at each lamp end, and shall have provisions to be locked into place, utilizing the luminaire's lamp-locking clips. Lamps shall produce 253 lumens per foot (30TC Warm White Triphosphor) and manufacturer shall provide independent test lab reports to substantiate.

Integral Ballasts: Shall be noiseless, electronic 990-volt, high-output, instant-start cold cathode, class P thermally protected, and shall automatically de-energize upon removal of lamps from the luminaire. Ballast power factor shall be >.95

Dimming: Luminaires shall be independently dimmable via a 3-wire fluorescent dimming system and shall dim to 1%.

Approvals: Luminaire shall be UL and cUL-listed under UL category: IEUZ Fluorescent surface-mounted luminaires.

Manufacturer: Shall be Cathode Lighting Systems Inc., Gaithersburg, MD - USA (800) 551-5012.



8020 Queenair Drive, Gaithersburg, MD 20879 USA • ph: 301 921 4120 • fax: 301 963 3050
 email: info@CathodeLightingSystems.com • website: www.CathodeLightingSystems.com